

外形寸法图

CH7625-A

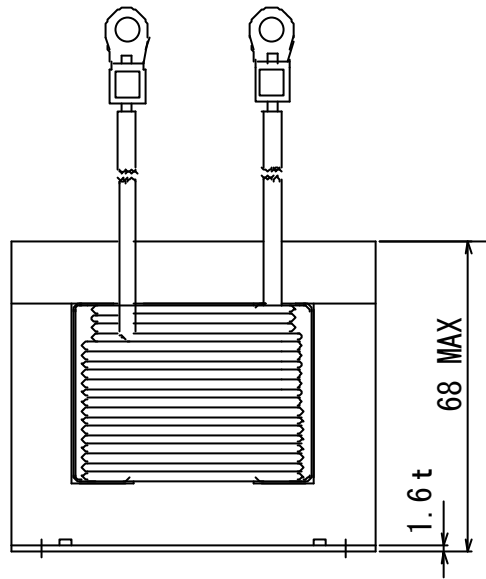
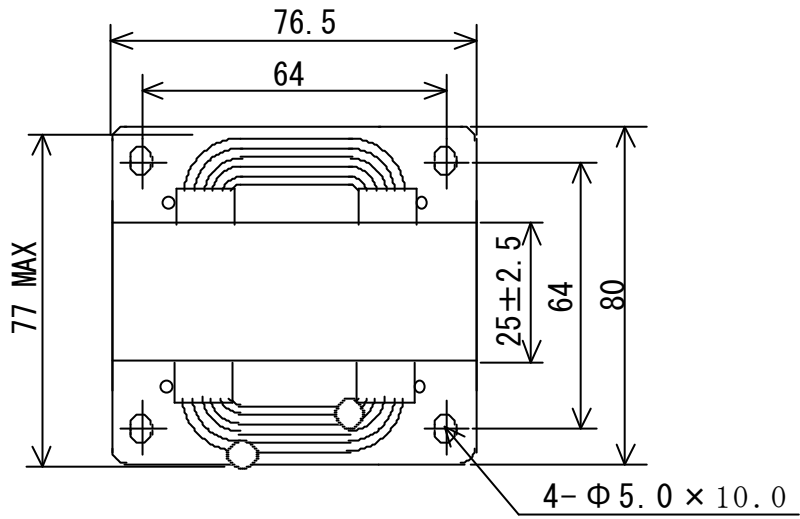

单位 : mm
指定外公差 : ±1.0