

外形寸法図

CH7032-A

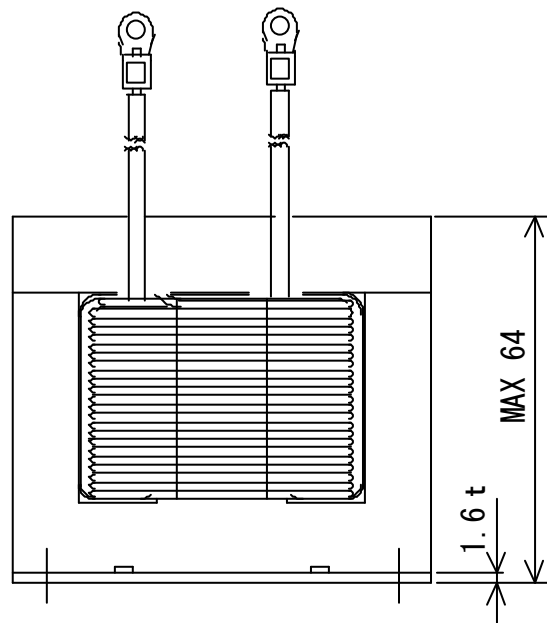
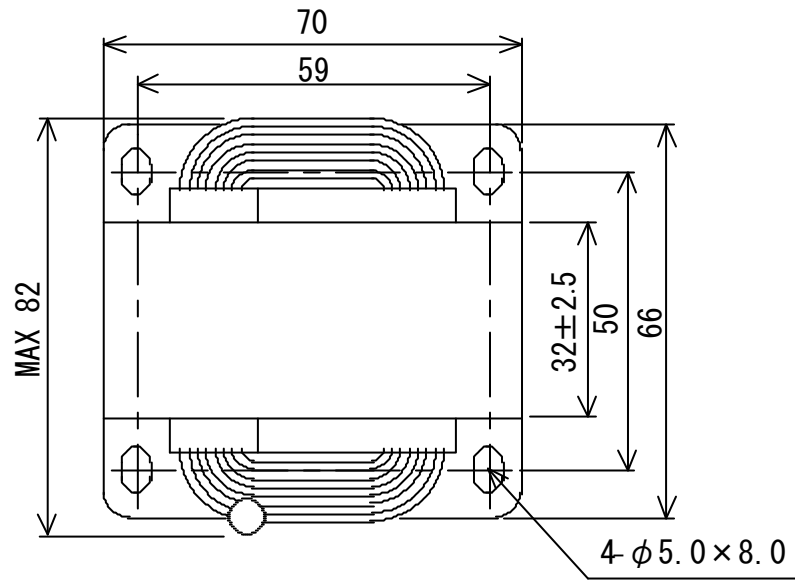

単位 : mm
指定外公差 : ±1.0