

外形寸法図

CH7021-A

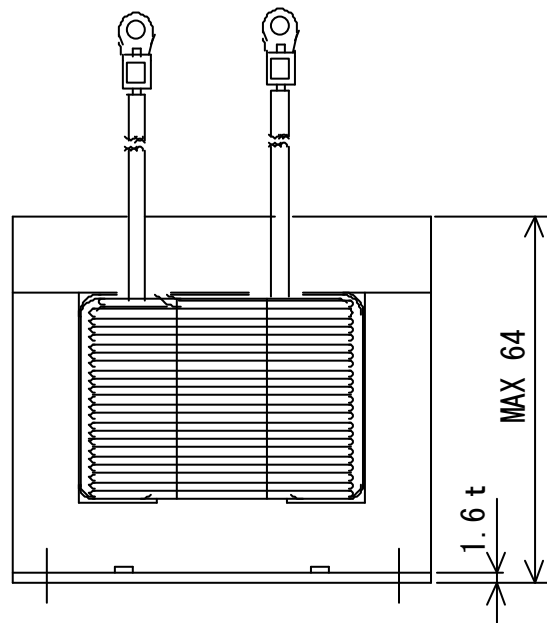
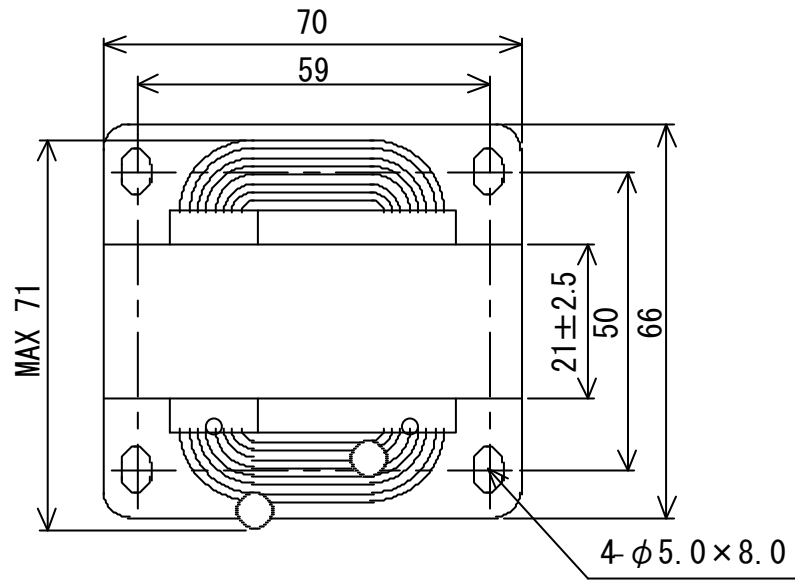

単位 : mm  
指定外公差 :  $\pm 1.0$